

REPAIR PARTS

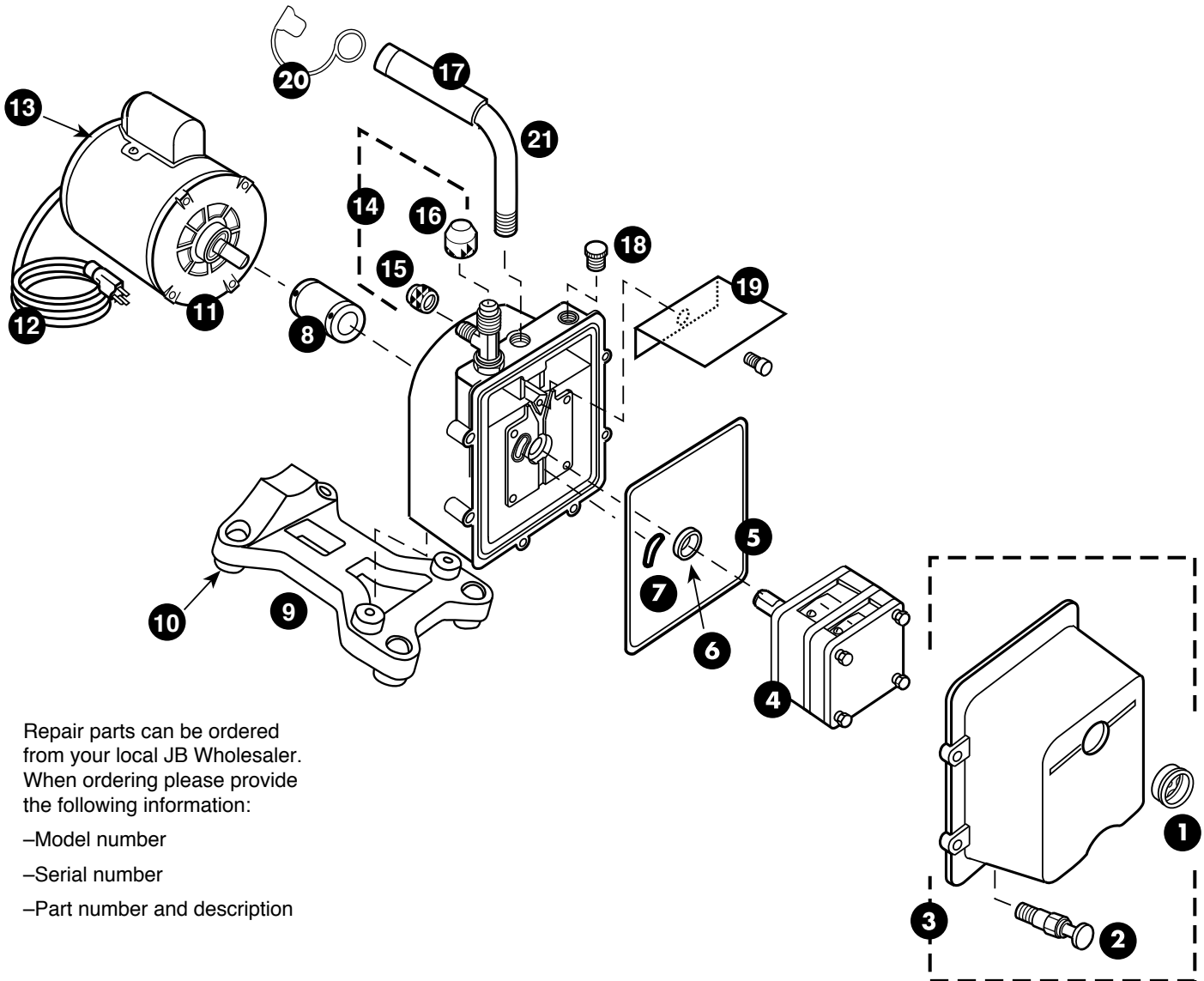

Repair parts can be ordered from your local JB Wholesaler. When ordering please provide the following information:

- Model number
- Serial number
- Part number and description

REF. NO.	PART NO.	DESCRIPTION
1	PR-1♦	Sight Glass
2	PR-2♦	Drain Valve
3	PR-10	Cover Assy. Includes Sight Glass and Drain Valve
4	PR-403	DV-3E Cartridge Complete w/O-Rings and Cover Seal
	PR-404	DV-4E Cartridge Complete w/O-Rings and Cover Seal
	PR-406	DV-6E Cartridge Complete w/O-Rings and Cover Seal
5	PR-217	Cover Seal
6	PR-3	Shaft Seal
7	PR-315	Trap Intake O-Ring
8	PR-20♦	Flexible Coupler (3 Parts)
	PR-308	Flexible Section Only
9	PR-62	Pump Base (Includes Rubber Feet)
10	PR-59	Pump Feet (Qty 2)

REF. NO.	PART NO.	DESCRIPTION
11	PR-206	1/2 HP, 115V Motor 60HZ w/Line Cord
	PR-207	1/2 HP, 115/230V, 50/60 HZ Motor w/Line Cord
12	PR-31	6' Line Cord 115V Emerson Motor
	PR-58	6' Line Cord 115V Marathon Motor
13	PR-54	Rocker-Switch 115V Emerson Motor (Wire Leads)
	PR-35	Rocker-Switch 115V Marathon Motor (Prongs)
14	PR-63♦	Intake Tee with With O-Ring
15	NFT5-4	1/4" O-Ring Cap
16	NFT5-6	3/8" O-Ring Cap
17	PR-205♦	Cushioned Handle With Cap End
18	PR-22	Oil Fill Plug With O-Ring
19	PR-40	Splash Guard with Screw
20	DV-EP-6 101	3/8" Red Plug For Handle
21	PR-205	Handle With Cushion Grip And End Cap

Not Shown

* PR-18 Cartridge Valve Repair Kit (Not Shown)

♦ Coat with thread sealant when replacing